

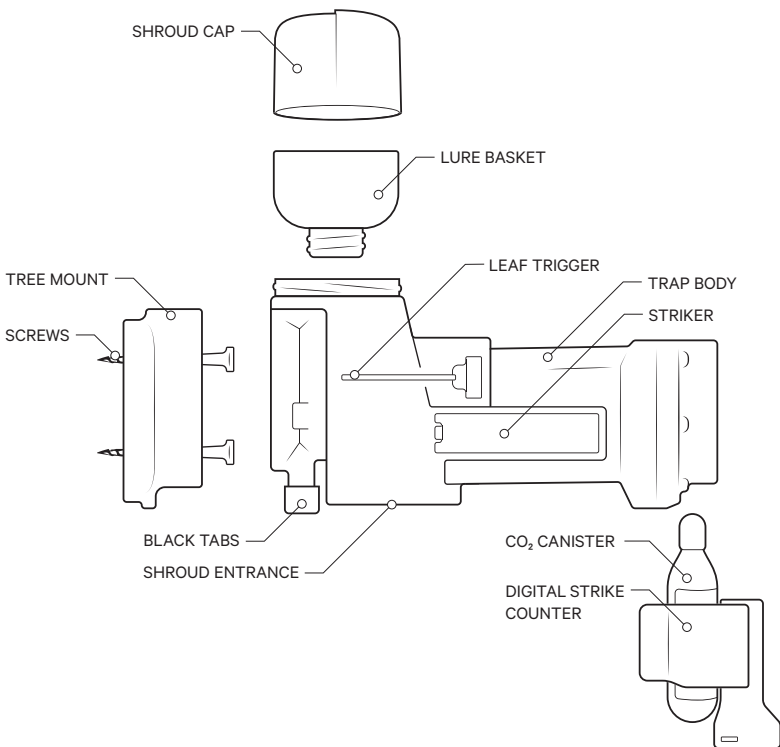

QUICK START GUIDE

A18 GREY SQUIRREL TRAP

YOUR TRAP – A18 GREY SQUIRREL



YOUR CONSTANT CONTROL SYSTEM

CONGRATULATIONS! You are now the owner of the world's most advanced pest control technology. Goodnature's self-resetting trapping system is designed so that your trap waits for the pest to activate it, instead of waiting for you to clear and lure it after each strike. We call this a constant control system – one that knocks down the existing grey squirrel population and is always available to manage the inevitable reinvasion.

Powered using compressed CO₂ gas, Goodnature technology combines superb design engineering principles and behavioural science with the highest manufacturing standards to deliver a trap that will kill up to 18 times per canister – the A18 Grey Squirrel Trap.

Our lures are scientifically developed to be long life, ensuring optimal field performance for minimal maintenance effort. Because they are toxin-free there is no risk of secondary poisoning to non-target species such as wildlife, pets, livestock and working animals. This toxin-free feature in conjunction with the strike mechanism gives the Goodnature A18 its certified A-Class humane status.

This quick start guide has been developed to help you get the best results you can and we hope you enjoy it, furthermore we appreciate any feedback you'd like to give us via our website – www.goodnaturetraps.co.uk

Happy trapping!

WHAT'S IN THE BOX

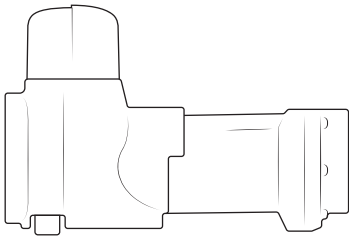

A18 GREY SQUIRREL TRAP

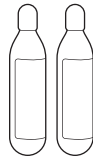

2 x CO₂ CANISTERS

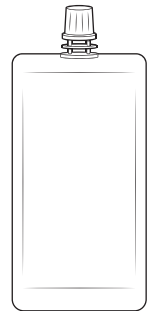

250 g LURE POUCH



DIGITAL STRIKE COUNTER



LURE BASKET

HOW IT WORKS

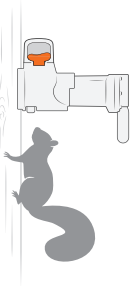

SMIFF SNIFF

Targeted long life lure attracts squirrels into the trap.



KAPOW!

Squirrels move the trigger to get to the lure, firing the trap.

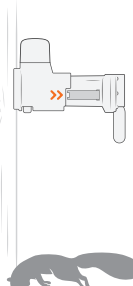

AUTO-RESET

The trap clears and resets immediately after an A-Class humane kill.

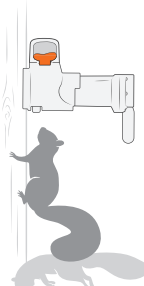

SMIFF SNIFF...

The long life lure continues to attract squirrels for constant control.



SCAVENGED

Different species scavenge the dead carcasses from below the trap.

INSTALLING YOUR TRAP

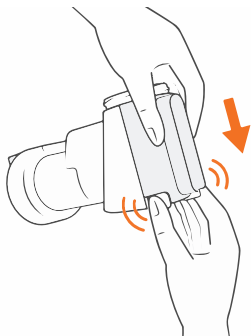

1. SEPARATE THE TREE MOUNT FROM THE TRAP BODY

Using your forefinger and thumb, press the Black Tabs inwards and ease the orange Tree Mount along and off the Trap Body.

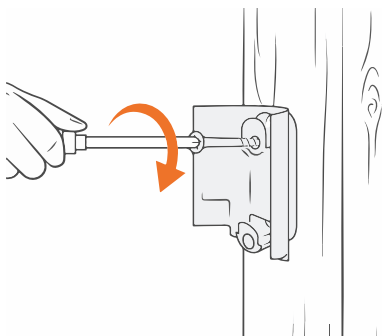

2. ATTACH THE TREE MOUNT

Using a screwdriver, screw in the orange Tree Mount waist-height above the ground onto a straight tree or post with clear footing. **Do not overtighten.**

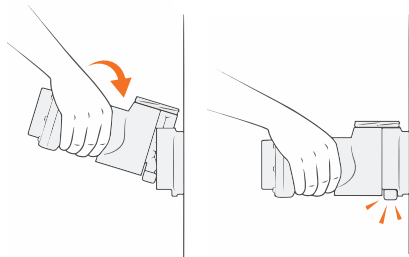

3. ATTACH THE TRAP BODY TO THE TREE MOUNT

Tilt the Trap Body backwards slightly and lower it onto the top locking tab of the Tree Mount. As you press downwards the Trap Body will be guided in toward the Tree Mount and lock in with a click.

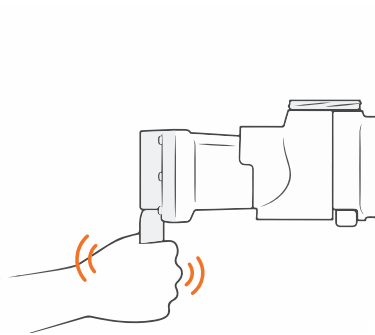

4. POWER/PRESSURISE THE TRAP

Take the CO₂ Canister, remove the black cap and be careful to keep the screw thread clean and free of debris. Screw in the canister until firm. **Hand tighten only.**

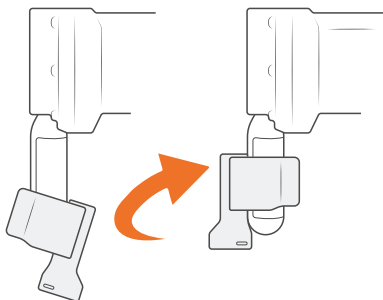

5. ATTACH THE DIGITAL STRIKE COUNTER

Wet the inside of the Counter's rubber strap for lubrication. Rotate the Counter anticlockwise as you ease it up the canister. **The Counter display must face directly away from the tree.**

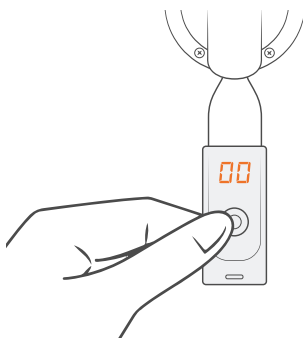

6. ZERO THE COUNTER

Zero the Counter by pressing the button and holding it down until the display shows '00'. The Counter goes to sleep a few seconds after the button is released.

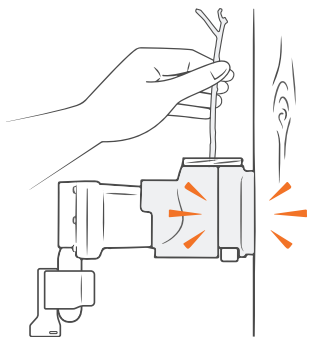

7. TEST-FIRE YOUR TRAP

To test fire your trap, reach a pen or twig down through the top of the trap and push down on the Leaf Trigger (steel wand). The Striker will discharge with a bang and then retract. **Keep your hands clear of the Shroud Entrance and always treat the trap as live.**

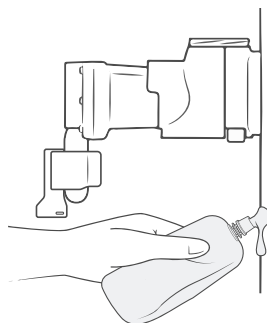

8. PRE-FEED THE TREE

Squeeze out a small amount of lure from the 250 g Lure Pouch and wipe it beneath the trap as pre-feed. This greatly enhances trapping success through attraction.

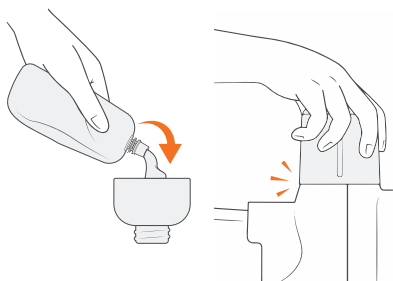

9. LURE THE TRAP AND REPLACE THE SHROUD CAP

After you have pre-fed the tree, squeeze out a grape sized dollop of lure into the Lure Basket, making sure lure is at the mouth of the basket. Screw the Lure Basket into the top of the trap, then screw on the Shroud Cap.

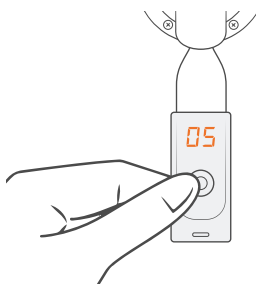

10. CHECKING THE COUNTER

To check the tally on the Counter, quickly press and release the button. The display will show the number killed. **Pressing and holding the button down zeroes the Counter.**

MAINTAINING YOUR TRAP

REFRESH THE LURE MONTHLY

While our lures are long life, they will eventually crust over or diminish in their scent when exposed to air. Once a month, remove and discard the spent lure from the basket and repeat steps 9 and 10 above.

Remember, any quality, humane pest control device is only as effective as the quality of the lure used to attract the pest. It is the lure that motivates the target pest to enter and activate the trap.

REPLACE THE GAS EVERY 6 MONTHS

You must change the gas canister every 6 months regardless of how many kills you've sighted or if your counter displays 18 strikes within 6 months.

Use the table below, put a note in your calendar or set an alarm on your phone to keep a record so you know when you need to replace your gas.

	Date Installed	6 TH Month Replacement	Trap Location
E.g.	06/03	06/09	Back of Garden Shed
Trap 1	_____	_____	_____
Trap 2	_____	_____	_____
Trap 3	_____	_____	_____

MOVING YOUR TRAP

1. DE-COUPLE

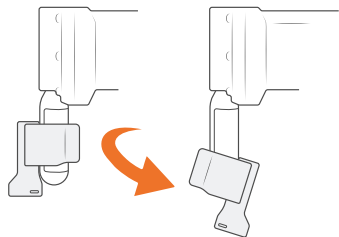

2. DE-GAS

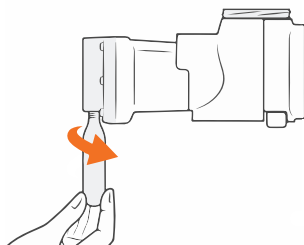

3. DE-PRESSURISE

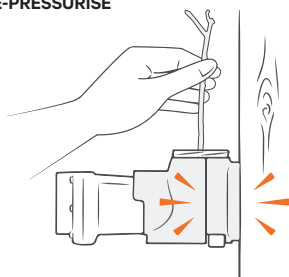

4. DETACH

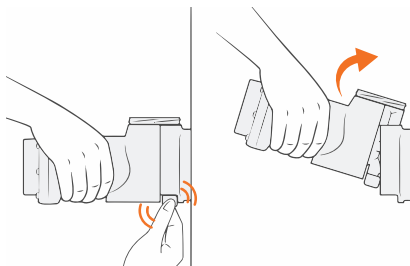

CONSTANT CONTROL

Rather than move your traps, it is better to add to the trapping network and increase your pest free area. If however, you need to move your trap or have found a better location for it, then it is very important that you follow the instructions below.

Goodnature develops products for the constant control of invasive pests. This is achieved by establishing a permanent network of traps to knock down target populations and then be ready for the inevitable reinvasion. Build your network.

HOW TO DO IT SAFELY

To move the trap, first **de-couple** the Counter and then **de-gas** the trap by unscrewing the current CO₂ canister from the trap. You may experience the noise of the remaining gas in the canister escaping, which may cause the canister to freeze rapidly.

WARNING:

Although the CO₂ Canister has been removed the trap may still be live (pressurised) with one charge remaining in its chamber. To **de-pressurise** the trap, firstly remove the Shroud Cap and unscrew the Lure Basket. Fire the remaining charge in the trap by reaching a stick down through the top and pushing down on the Leaf Trigger (steel wand). The Striker will discharge with a bang.

Always treat the trap as live until you have de-gassed and de-pressurised it. If the trap doesn't fire then it has run out of gas at some earlier point.

With the trap de-pressurised, your trap is now safe to **detach** from the tree. Place your palm beneath the Shroud Entrance and using your thumb and forefinger, squeeze the Black Tabs and with upward pressure pull the trap up and off the Tree Mount.

Always keep fingers clear of the Shroud Entrance.



TECHNICAL SUPPORT

FAQ'S, WARNINGS AND WARRANTY'S

www.goodnaturetraps.co.uk