

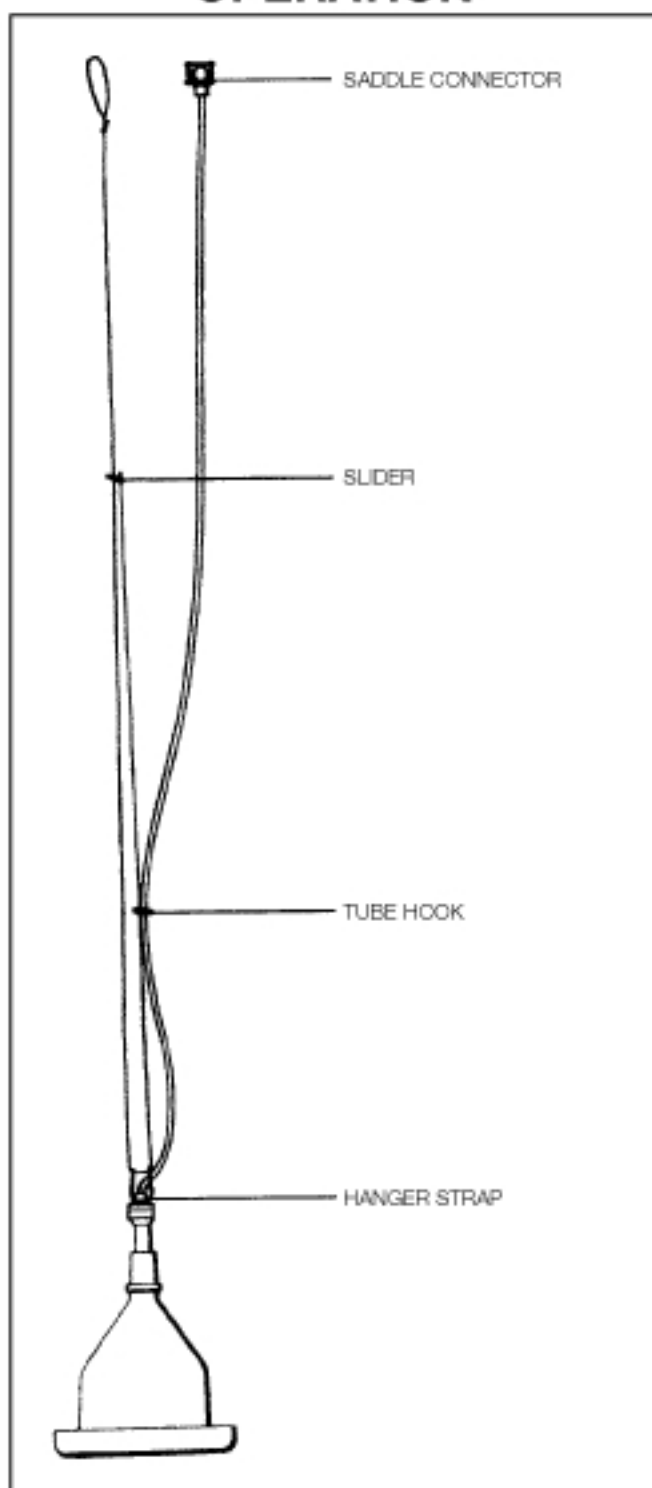

# WATERMASTER<sup>3E</sup>

## OPERATION



## PARTS LIST

### KEY

412747	SADDLE CONNECTOR COMPRESSION
(Part of 412747)	TUBE HOOK
412787	WATERMASTER TUBING NEW
411455	1/4" BSP NUT
412767	FILTER TOP COMPRESSION
411777	FILTER DISC
411782	STEM
413114	ADJUSTER COLLAR
411903	MAIN SPRING
411596	VALVE SPRING
411817	VALVE WASHER
411822	VALVE SEATING LP
412948	CONE WM3E
411898	HANGER STRAP
411943	BALLAST BOWL
411481	SLIDER
412079	BALLAST RETAINING LID
413430	ANTI-SPLASH RING
411496	CORD PLASTIC COVERED

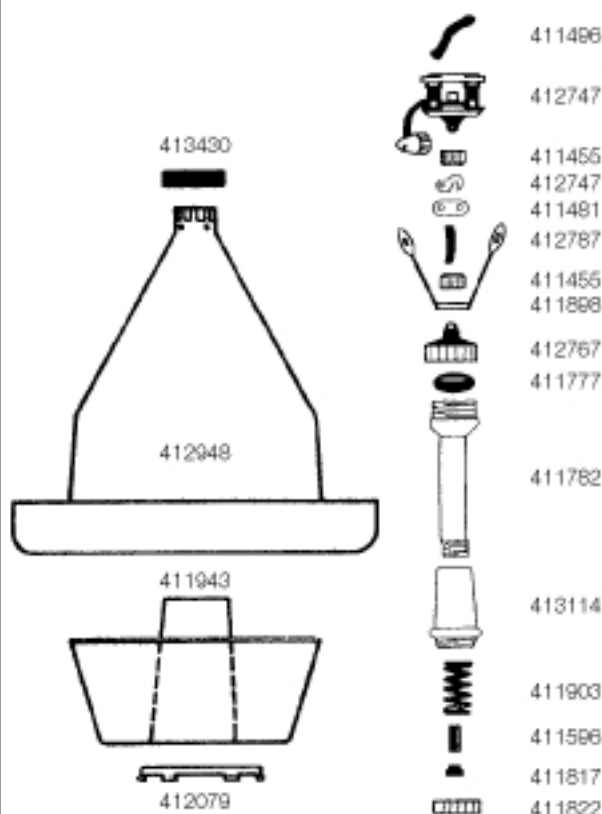

\*411823 CHICK RING IS OPTIONAL EXTRA

# Collins Nets Ltd

01308 485422 - [info@collinsnets.co.uk](mailto:info@collinsnets.co.uk)

[www.collinsnets.co.uk](http://www.collinsnets.co.uk)

# WATERMASTER 3E

## Assembly & Operating Instructions

### PLUMBING

#### General Installation:

Internal plumbing should be galvanised 1/2" or 3/4" piping. Plastic piping may be used but well supported, as sagging can cause air locks. Connect Waterers to the piping with the Saddle Connector supplied. Drill a 9/32" or 5/16" hole into the piping and place the Saddle Clamp over. Do not overtighten the Saddle Clamp as this may create distortion and leakage.

Although the Watermaster 3E is fitted with its own filter element, a line filter in each house installation is recommended.

The Bec Watermaster 3E is designed to work on a low pressure water supply, that is below 5p.s.i. (.35 bar). Ideally the supply should be from a header tank 8-12ft. above the ground.

### 1 ASSEMBLY

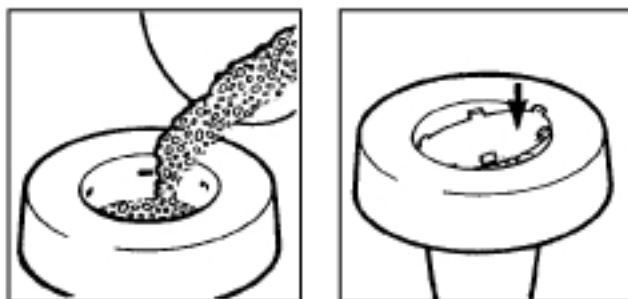

Remove all components from carton. Fill the recess in the underside of the black ballast bowl with ballast or sand, up to just below the holes at the top of the recess (3lbs or 1.35kilos). Place the ballast retaining lid (with six lugs uppermost) into the ballast recess, fitting two adjacent lugs into their recesses. Then press each of the remaining four lugs home working round in a clockwise direction.

**IT IS IMPORTANT THAT THE CORRECT WEIGHT OF BALLAST IS PUT INTO THE RECESS OF THE BLACK BALLAST BOWL FOR THE CORRECT FUNCTIONING OF THE DRINKER.**

Place the ballast bowl with the apex of the recess upwards onto a flat firm surface and wet the rim all round, to aid assembly. Place the drinker cone over the bowl squarely and lower it until it reached the moulded securing ring. Press down firmly to lock the bowl rim into this securing ring. When fitted correctly, the ring should be just visible all round when the assembly is viewed from the underside. Finally, place the black chick saving ring into the trough of the cone if required for use with day old or very young stock.

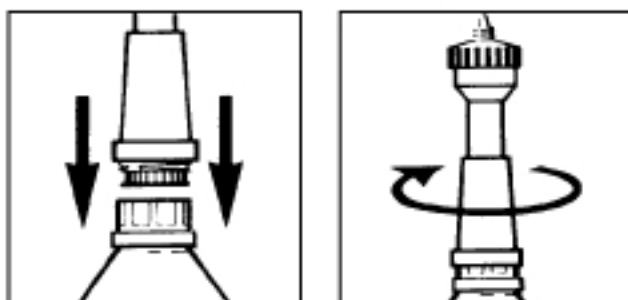
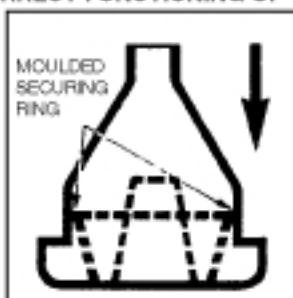

Insert the black valve unit into the top of the cone, valve downwards. Before inserting the valve into the top of the cone, check to ensure the top and bottom caps (part nos 412767

### 1 ASSEMBLY - continued

and 411822) are not loose. Push the black adjuster collar down until it locates into the threads. **Care must be taken not to cross the threads.** Continue screwing in a clockwise direction until the ratchet is reached. Normally, eight clicks give a starting point for adjustment. Level can then be controlled by rotating the adjuster collar clockwise for more depth, anti-clockwise for less. Watermasters should be installed and filled at least 24 hours before introducing the birds to ensure that they are working correctly. If a unit overfills, carefully dismantle the valve and check for any dirt or contamination. Reassemble and retest.

### 2 TUBE CONNECTIONS

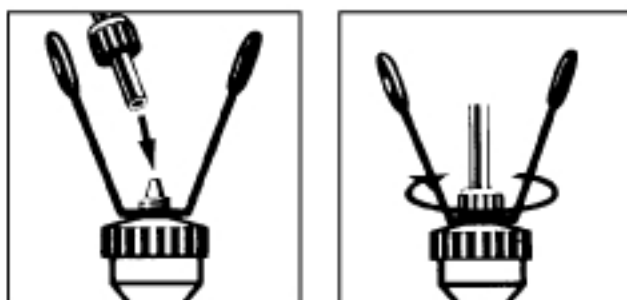

Place a nut, thread outwards, onto the end of the tube. Push Hanger Strap over filter top. Push the tube onto the tapered end of the filter top as far as it will go. Tighten the nut firmly. Repeat at the Saddle Connector end.

### 3 SUSPENSION

Tie a looped knot in one end of the hanging cord. Pass the other end through one eye of the Slider, then through the small eye of the Tube Hook, then through both eyes of the Hanger Strap. Finally, pass this end back up to the Slider and knot it through the remaining eye. The BEC Watermaster 3E is suspended by this cord from the looped knot end. (SEE SUSPENSION DIAGRAM OVERLEAF).

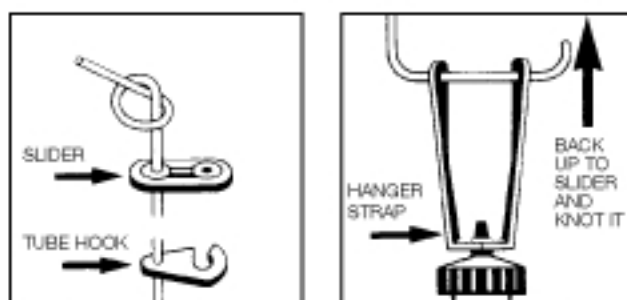

For the most efficient operation, it is necessary to suspend the Waterers above the height of the backs of the birds. With large birds and Layers the Waterers should be set at about their eye level.

**PLEASE SEE OVERLEAF FOR COMPLETED ASSEMBLY DIAGRAM AND SPARE PARTS LIST CODING**